

## UIG-2

Universal Interface

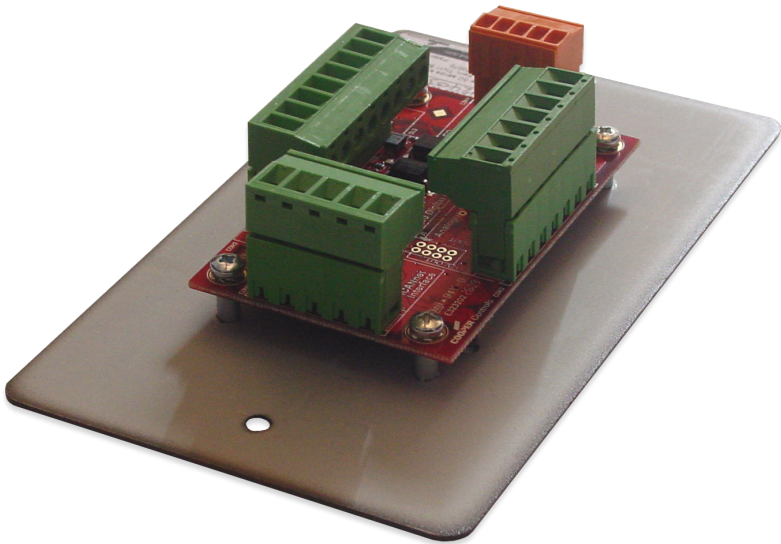

## Contents

Introduction	2
Dimensions	2
Specification	3-4
Installation	4
iCAN Network Connections	5
Input and Output Connection	6
Opto-isolated Digital Inputs	6
LED Output Drives	7
Operation	7

## Introduction

The Universal Interface (UIG-2) provides a cost effective interface between an iCANnet system and other control systems. Fitting in a standard double gang UK style backbox and powered through the iCAN network, this compact versatile unit can be mounted virtually anywhere. It has four optically-isolated digital inputs and a further four inputs configurable for either digital or analogue use. All inputs are programmable as to their function. In addition to the inputs there are four LED output drives for visual feedback of switch activity.

The unit enables input controls such as partition switches and faders to be used with iCANnet systems. With configurable room join functions, just moving room partitions can open or close contacts to enable individual or combined room control.

## Dimensions

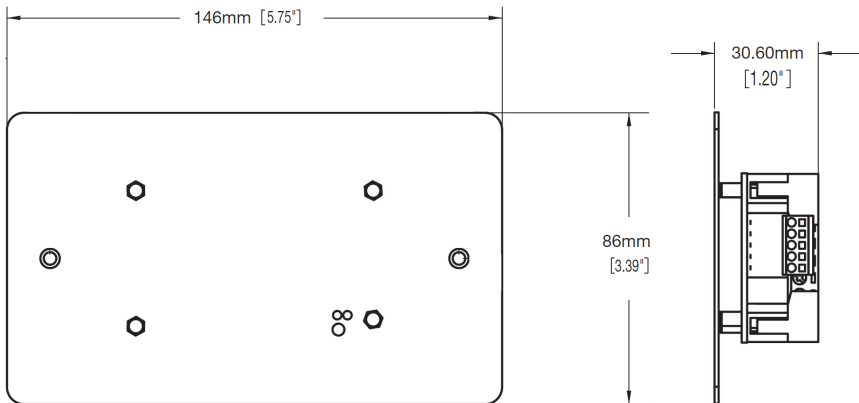

# Specification

## Inputs

### 4 Optically-isolated digital inputs

- A. Requires 5 - 24 Vdc supplied from +12V\_opto to 0V\_opto terminals
- B. Optical isolation offers improved performance in electrically noise environments
- C. Internal 12Vdc current limited (50mA) supply available where an external supply is not required; using this supply requires by-passing the optical isolation of these inputs
- D. Opto-isolated digital inputs work with:
1. Switch closure from the IN\_opto to 0V\_opto
    - For use with both momentary and maintained inputs
    - Minimum momentary input pulse duration 20 msec
    - Switch will see up to 16mA when closed
  2. Open collector NPN active low circuit
    - On-state voltage  $\leq 1$  volt and capable of sinking 16 mA
    - Collector-emitter leakage current  $\leq 500$  nA
    - Collector-emitter voltage  $\geq$  supply voltage
  3. Actively driven circuit
    - Active low voltage  $\leq 1$  volt and capable of sinking 16 mA
    - Active high voltage  $\geq$  supply - 0.25 volts
- E. All opto-isolated digital inputs wire with 2 part connectors with screw terminals. Wire sizes 4mm<sup>2</sup> (12 AWG) to 0.25mm<sup>2</sup> (24 AWG).

### 4 Analogue / digital inputs

- A. Individually programmable as analogue or digital inputs
- B. 5Vdc & 12Vdc current limited (50mA total) regulated supplies available for analogue / digital input devices
- C. Analogue input mode:
1. Suitable for use with rotary and linear variable resistors
  2. Reads input voltages from 0 - 10 Vdc
  3. Inputs protected for use up to 12 Vdc
- D. Digital input mode works with:
1. Switch closure from the IN\_A/D to 0V\_A/D
    - For use with both momentary and maintained inputs
    - Minimum momentary input pulse duration 20 msec
    - Switch will see up to 60uA when closed
  2. Open collector NPN active low circuit
    - On-state voltage  $\leq 500$ mV and capable of sinking 60uA
    - Collector-emitter leakage current  $\leq 10$  uA
    - Collector-emitter voltage  $\geq$  supply voltage
  3. Actively driven circuit
    - Active low voltage  $\leq 500$ mV and capable of sinking 60uA
    - Active high voltage  $\geq$  supply - 1 volt
  4. All analogue / digital inputs wire with 2 part connectors with screw terminals. Wire sizes 4mm<sup>2</sup> (12 AWG) to 0.25mm<sup>2</sup> (24 AWG).

## Outputs

### 4 LED Outputs

- A. LED outputs drive remote indicators
- B. Each output provides a 10mA supply capable of driving LED's up to a forward drop of 6.7V.
- C. Indicates input status when opto-isolated input are configured for scene selection
- D. Can also be configured for indication of other functions
- E. All LED outputs wire with 2 part connectors with screw terminals. Wire sizes 4mm<sup>2</sup> (12 AWG) to 0.25mm<sup>2</sup> (24 AWG).

## Functions

- A. 16 sequences of up to 128 steps each
- B. 4 room joins with up to 3 partitions each

## Electrical and network

- A. Supply: 12Vdc from the iCANnet network.
- B. Counts as 1 device load when used with 4 LED outputs or with 1 sensor.
- C. Every additional 2 sensors increases the supply load by 1 device.
- D. Will operate from 12Vdc to 18Vdc.
- E. iCANnet network connection: 2 part connector with screw terminals. Wire sizes from 4mm<sup>2</sup> (12AWG) – 0.25mm<sup>2</sup> (24AWG).
- F. Maximum wiring distance of inputs should not exceed 10m (32 feet).

## Installation

### Supplied Parts

The universal interface is supplied with a mounting plate for easy attachment to a standard double gang UK style electrical back box (not included).

### Mounting

The mounting plate can be removed if it is not required, allowing the universal interface to be mounted in any convenient location. If doing so, you must ensure that the universal interface is supported such that it is electrically isolated from any electrically conductive material in that location. The unit must be installed in a dry, ventilated location where ambient temperature and humidity are within the operating limits of the product.

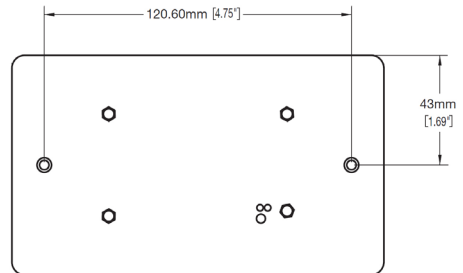

### Ambient atmosphere requirements

Temperature: 0°C to +40°C (32°F to 104°F)  
Humidity: 0 to 95% non-condensing.

# iCAN Network Connections

Connection to the iCAN network is made via a removable 5-way connector block.

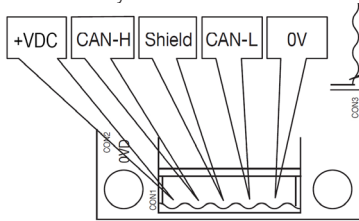

Function	iCANnet Cable Colours
0V	Black
CAN L	Blue
Shield	Silver
CAN H	White
+12Vdc	Red

Maximum segment distance: 500m (1640 ft)  
 Devices per segment: 100 (without bridge or repeater)

Consult iLight for information on alternative cable types.

**IMPORTANT NOTE:** Connecting a mains potential cable to the iCAN Network terminals is likely to damage the unit and other devices connected, and invalidate warranty.

## Network Termination

The iCAN network follows a daisy chain topology that requires termination on the devices located at either end of the network.

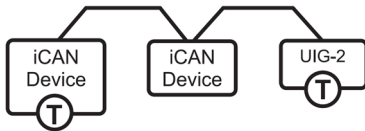

The UIG-2 is supplied with termination disabled as standard. If it is connected as an end device in the iCAN network, you need to move the jumper to enable termination.

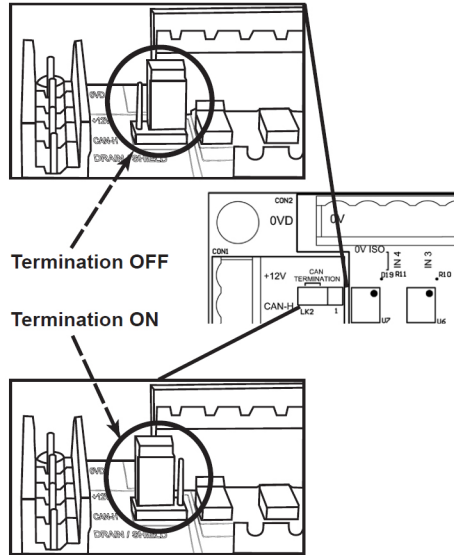

## Operation Indicators

The UIG-2 has red and green indicators, visible on the front of the unit, to assist with configuration and troubleshooting.

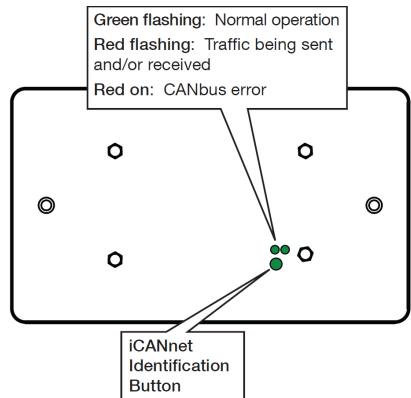

## iCANnet Identification Button

The UIG-2 features a small button, accessible through the front panel, which sends an identification message across the iCANnet network when pressed.

## Input and Output Connection

### Analogue / Digital Inputs

The UIG-2 has 4 inputs that can be individually configured for either analogue or digital operation.

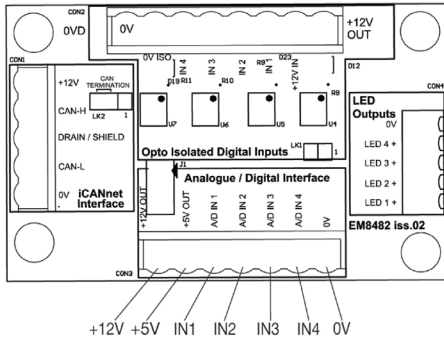

The function of each input is programmable with iCANsoft.

### Analogue Mode

In analogue mode, the inputs have a voltage range of 0V to 10V. The input device is connected across the appropriate input and the 0V reference. Wire distance from the device to the UIG-2 should not exceed 10m (32 feet).

50mA current limited, regulated voltage sources of 5V and 12V are also available at the connector for devices such as variable resistors without the need for an external supply.

Should the power supply to the UIG-2 be below 12V, then the 12V source will follow the UIG-2 supply voltage.

### Digital Mode

In digital mode, switches can be connected between the appropriate input and 0V. The input functions can be programmed to operate on both a switch closure and release.

## Opto-isolated Digital Inputs

The unit has four opto-isolated digital inputs.

These inputs offer greater electrical protection than the analogue/digital inputs, but can only be used in digital mode.

The opto-isolation also offers better electrical noise rejection for those installations where this could be a problem.

To use these inputs, an external supply is required, connected to the 12Vin pin.

0V<sub>Opto</sub> is provided as a landing connection for convenience. An LED gives visual indication when a supply is connected across 12Vin and 0V<sub>Opto</sub>.

Instead of an external supply, the 50mA current limited 12V<sub>out</sub> supply can be used, however this will bypass the optical isolation. To use this supply, connect 12V<sub>out</sub> to 12Vin and 0V to 0V<sub>Opto</sub> at the connector.

Switch closure is made between the input and 0V<sub>Opto</sub>. Wire distance from the device to the UIG-2 should not exceed 10m (32 feet).

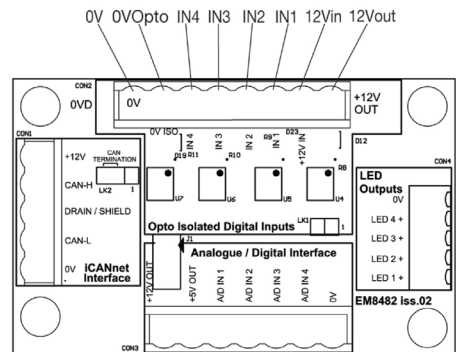

## LED Output Drives

The unit has four LED drive outputs, each rated at 6.7V 10mA, which can be used to give visual indication of programmed functions.

The outputs will indicate input selection for the optoisolated digital inputs when they are configured for scene selection.

The LED outputs can also be configured from iCANsoft for indication of other functions.

LEDs are connected between the appropriate output and the 0V connection. Wire distance from the device to the UIG-2 should not exceed 10m (32 feet).

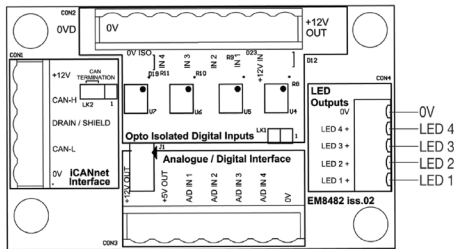

## Operation

The UIG-2 provides the standard input functions which are available from the iCANsoft application. For details about the general use of iCANsoft, please refer to the system Manual. In addition, the UIG-2 provides sequences and partitioning/ room join functions.

### Sequences

Sequences allow a number of individual actions (steps) to be linked together in order to cause multiple operations from a single trigger action.

The UIG-2 provides up to 16 sequences with up to 128 steps each, with or without time delays between steps.

The iCANsoft System Manual gives more details on programming sequences.

### Partitioning/Room Join

The UIG-2 allows for the programming of simple room join functions, by using partitions.

The room join function operates by linking areas.

A physical room partition can be detected by a switch on the UIG-2 inputs. When the partition is opened, an action in one of the areas will cause the equivalent action in the other area.

The UIG-2 allows 4 room joins with up to 3 partitions each.

A Technical Note on Room Joins and partitioning, with examples, is available.

## iLight Technical Support

Tel: +44 (0)844 324 9100 (available Mon-Fri 9am-5pm GMT)

Email: [cctechsupport@signify.com](mailto:cctechsupport@signify.com)

Web: [www.iLight.co.uk](http://www.iLight.co.uk)

---

All products manufactured by iLight are warranted to be free from defects in material and workmanship and shall conform to and perform in accordance with Seller's written specifications. This warranty will be limited to the repair or replacement, at Seller's discretion, of any such goods found to be defective, upon their authorized return to Seller. This limited warranty does not apply if the goods have been damaged by accident, abuse, misuse, modification or misapplication, by damage during shipment or by improper service.

There are no warranties, which extend beyond the hereinabove-limited warranty, INCLUDING, BUT NOT LIMITED TO, THE IMPLIED WARRANTY OF MERCHANTABILITY AND THE IMPLIED WARRANTY OF FITNESS.

No employee, agent, dealer, or other person is authorised to give any warranties on behalf of the Seller or to assume for the Seller any other liability in connection with any of its goods except in writing and signed by the Seller. The Seller makes no representation that the goods comply with any present or future federal, state or local regulation or ordinance. Compliance is the Buyer's responsibility.

The use of the Seller's goods should be in accordance with the provision of the National Electrical Code, UL and/or other industry or military standards that are pertinent to the particular end use. Installation or use not in accordance with these codes and standards could be hazardous.



### iLight

Usk House, Lakeside, Llantarnam Park,  
Cwmbran, NP44 3HD, UK

t: +44 (0)1923 495495    [enquiries@ilight.co.uk](mailto:enquiries@ilight.co.uk)  
[www.ilight.co.uk](http://www.ilight.co.uk)

Document: UIG-2 9850-000809-01