



PPAD-C-MB-DALI-ADDR

Miniature Integration Presence Detector iLight DALI Network - SCMD2/4

Overview



The PPAD-C-MB-DALI-ADDR is a combined passive infrared (PIR) motion sensor and photocell designed to be part of a iLight DALI Network - SCMD2/4.

Functioning as a presence detector, the unit returns occupancy data to the network.

The photocell provides a lux level measurement value to the network.

Features

Sensor head

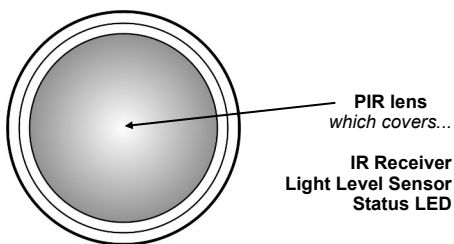

PIR Sensor

Detects movement within the unit's detection range, allowing load control in response to changes in occupancy.

IR Receiver



Receives control and programming commands from an IR (infrared) handset.

Light Level Sensor

Measures the overall light level in the detection area

Status LEDs

The LED flashes **Red** to indicate the following:

Walk Test LED active	 when movement is detected
Valid setting received	

Detection diagram

Range

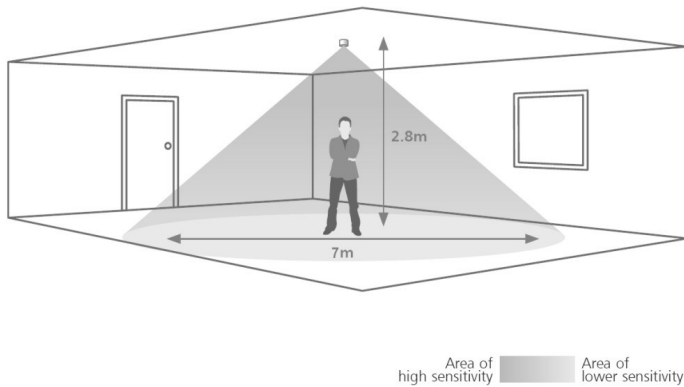

Note: illustration shows an average of the walk across

Walk across

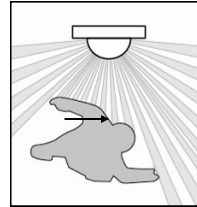

Height	Range Diameter
7m	16m
2.8m	9m

Walk towards

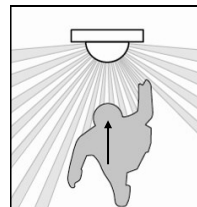

Height	Range Diameter
7m	10m
2.8m	5m

Installation PPAD-C-MB-DALI-ADDR

Choosing a Suitable Location

The detector should be sited so that the occupants of the room fall inside the detection pattern shown on page 1, at a recommended ceiling height of 2.8m. Note that the lower the sensor is installed the smaller the detection range will be, subject to the parameters shown on the detection diagram.

- Avoid direct sunlight entering the sensor.
- Do not site within 1m of forced air heating or ventilation.
- Do not fix to a vibrating surface.
- Do not exceed maximum length of cable (300m) on 1.5mm² data bus.
- Do not exceed maximum bus loading (250mA).
- Do not exceed maximum of 8 sensors per DALI bus.

Flush Mount

A 32mm diameter cut-out is required. Use the flush mount clip as shown.

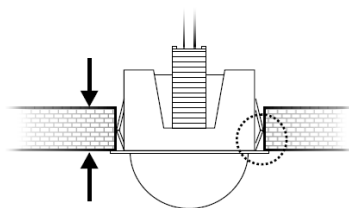

The small spring arms support mounting materials <6mm thick whilst the long spring arms support materials of greater thicknesses.

1

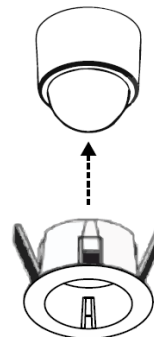

2

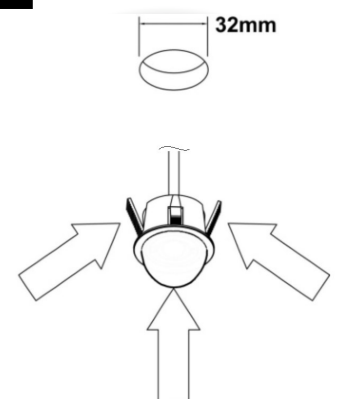

Wiring

The PPAD-C-MB-DALI-ADDR IS supplied with 1m, 2 core 1.5mm² double insulated cable to connect to the iLight DALI Network - SCMD2/4. The device is designed to operate correctly polarity-free.

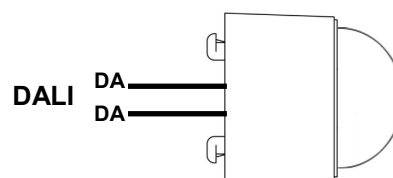

Technical data

Dimensions	See diagrams opposite	
Weight	0.10kg	
Supply Voltage	9.5VDC—22.5VDC via DALI	
Supply Current	8mA	
Temperature	-10°C to 35°C	
Humidity	5 to 95% non-condensing	
Material (casing)	Flame retardant ABS and PC/ABS	
Type	Class 2	
IP rating	PPAD-C-MB-DALI-ADDR	IP40

Compliance EMC-2014/30/EU
LVD-2014/35/EU



Flush Mount Clip

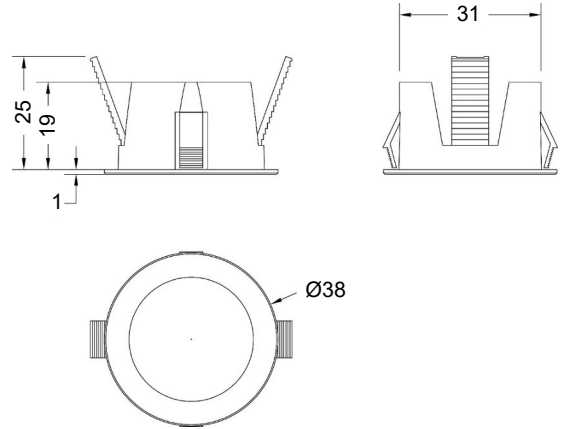

Sensor Head Dimensions:

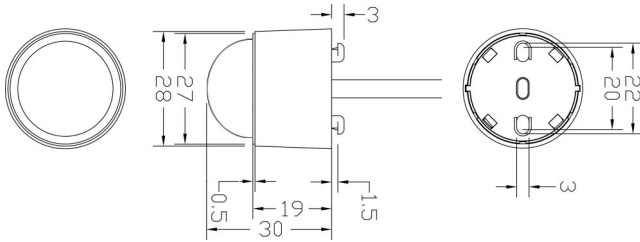

Part numbers

Detector	Part number	Description
	PPAD-C-MB-DALI-ADDR	Miniature integration presence detector

IMPORTANT NOTICE!

This device should be installed by a qualified electrician in accordance with the latest edition of the IEE Wiring Regulations and any applicable Building Regulations.



iLight
Usk House, Lakeside
Llantarnam Park,
Cwmbran, NP44 3HD, UK
Tel: +44 (0) 1923495495
enquiries@ilight.co.uk
www.ilight.co.uk