



PPAD-C-MB-EXT-DALI-ADDR

Miniature Integration IP Presence Detector iLight DALI Network - SCMD2/4

Overview



The PPAD-C-MB -EXT-DALI-ADDR is a combined passive infrared (PIR) motion sensor and photocell designed to be part of a iLight DALI Network - SCMD2/4.

Functioning as a presence detector, the unit returns occupancy data to the network.

The photocell provides a lux level measurement value to the network.

Features

Sensor head

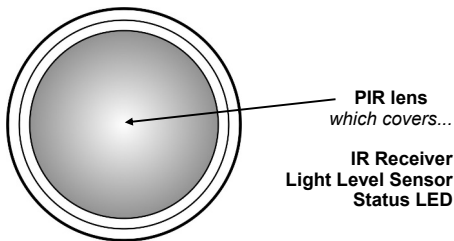

PIR Sensor

Detects movement within the unit's detection range, allowing load control in response to changes in occupancy.

IR Receiver



Receives control and programming commands from an IR (infrared) handset.

Light Level Sensor

Measures the overall light level in the detection area

Status LEDs

The LED flashes **Red** to indicate the following:

Walk Test LED active	 when movement is detected
Valid setting received	

Detection diagram

Range

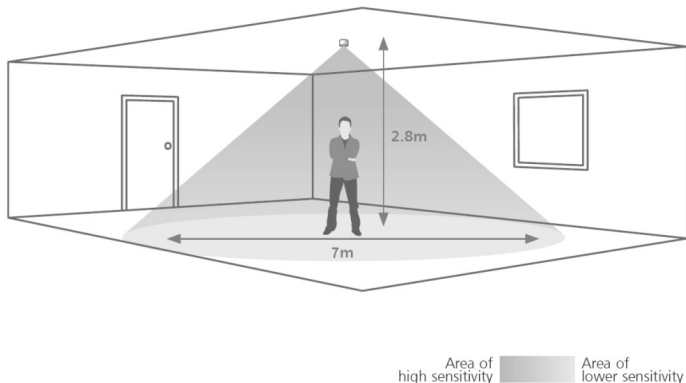

Note: illustration shows an average of the walk across

Walk across

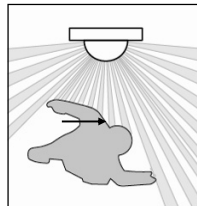

Height	Range Diameter
7m	16m
2.8m	9m

Walk towards

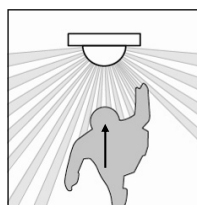

Height	Range Diameter
7m	10m
2.8m	5m

Installation PPAD-C-MB-EXT-DALI-ADDR

Choosing a Suitable Location

The detector should be sited so that the occupants of the room fall inside the detection pattern shown previously, at a recommended ceiling height of 2.8m. Note that the lower the sensor is installed the smaller the detection range will be, subject to the parameters shown on the detection diagram.

- Avoid direct sunlight entering the sensor.
- Do not site within 1m of forced air heating or ventilation.
- Do not fix to a vibrating surface.
- Do not exceed maximum length of cable (300m) on 1.5mm² data bus.
- Do not exceed maximum bus loading (250mA).
- Do not exceed maximum of 8 sensors per DALI bus.

Mounting

This product can be mounted using the provided thread and gasket as shown. A 32mm diameter hole cut-out will be required.

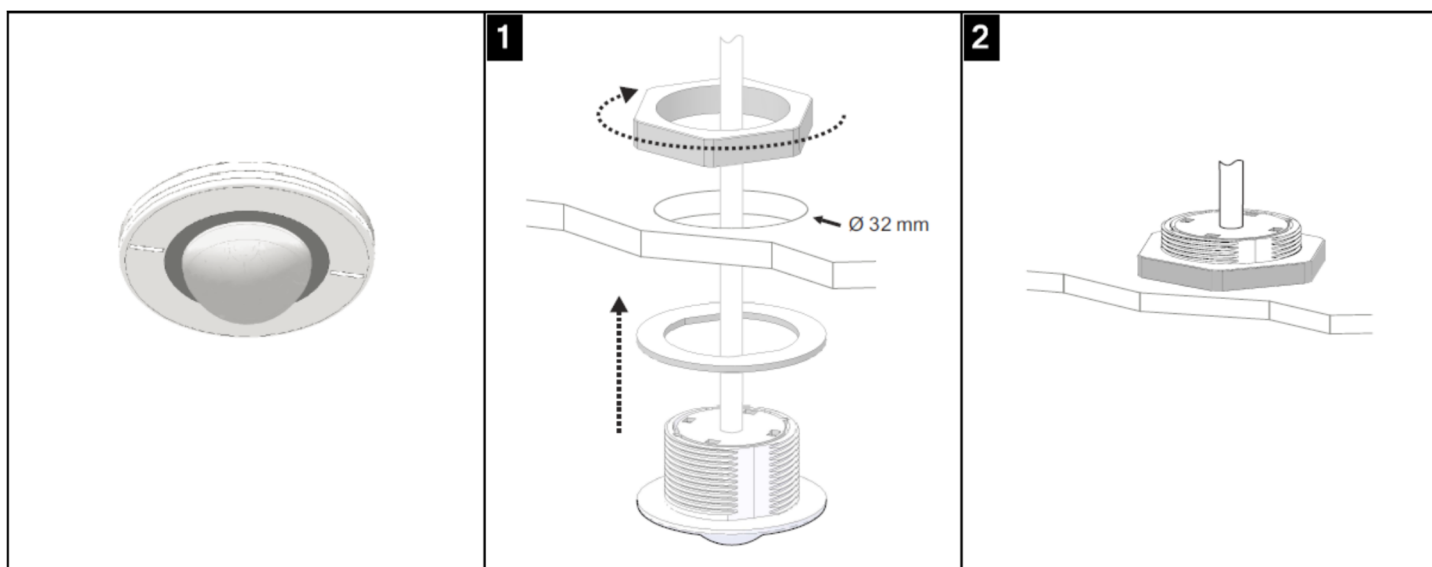

The PPAD-C-MB-EXT-DALI-ADDR IS supplied with 1m, 2 core 1.5mm² double insulated cable to connect to the iLight DALI Network - SCMD2/4. The device is designed to operate correctly polarity-free.

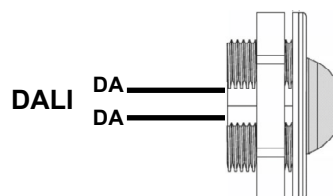

Technical data

Dimensions	See diagrams opposite
Weight	0.10kg
Supply Voltage	9.5VDC—22.5VDC via DALI
Supply Current	8mA
Temperature	-10°C to 35°C
Humidity	5 to 95% non-condensing
Material (casing)	Flame retardant ABS and PC/ABS
Type	Class 2
IP rating	PPAD-C-MB-EXT-DALI-ADDR IP65 (BS60598-1 2015 to 15 minutes)

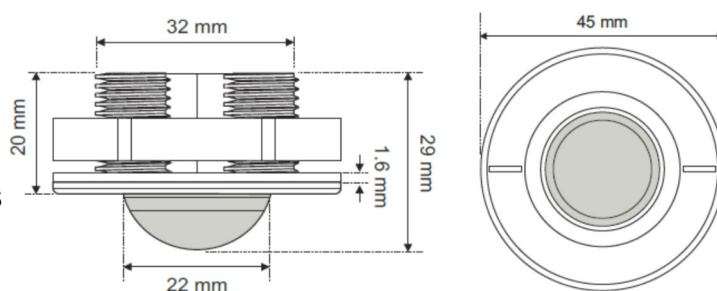

Compliance

EMC-2014/30/EU
LVD-2014/35/EU



Part numbers

	Part number	Description
Detector	PPAD-C-MB-EXT-DALI-ADDR	Miniature IP integration presence detector

IMPORTANT NOTICE!

This device should be installed by a qualified electrician in accordance with the latest edition of the IEE Wiring Regulations and any



Cooper Lighting Solutions

Usk House, Lakeside
Llantarnam Park,
Cwmbran, NP44 3HD, UK
Tel: +44 (0)1633 838088
Fax: +44 (0)1633 867880
info@cooperlighting.co.uk
www.cooperlighting.co.uk