

## SCD24

24 Channel DMX Source Controller



# Contents

<b>Introduction</b>	<b>3</b>
<b>Dimensions</b>	<b>3</b>
<b>Technical Data</b>	<b>3</b>
<b>Mounting</b>	<b>4</b>
<b>DMX Connections</b>	<b>4</b>
<b>Connecting to the Mains</b>	<b>4</b>
<b>Network Connections</b>	<b>5</b>
<b>Network Termination</b>	<b>5</b>
<b>Service Switches and LEDs</b>	<b>6</b>



**WARNING HAZARDOUS VOLTAGES  
DISCONNECT FROM SUPPLY  
BEFORE REMOVING COVERS**

NO USER SERVICEABLE PARTS INSIDE  
SERVICE BY QUALIFIED PERSONNEL ONLY



## WARNING

- To reduce the risk of fire or electric shock,  
DO NOT expose this device to rain or moisture.  
DO NOT energise unless the front cover is in place.
- This device must be earthed.
- Installation, programming and maintenance must be carried out by qualified personnel.
- Cooper Controls cannot accept responsibility for repairs or modifications that are not competently executed and in accordance with service or upgrade information.



CE compliant to all relevant standards

# Introduction

The iLight 24 channel DMX source controller is designed to provide control of any DMX512 controllable device. This product is of particular use for controlling DMX LED colour changing units and entertainment devices.

Each channel can be assigned a DMX channel from within the iLight programming software. The SCD24 can be controlled like any other iLight Source Controller using any of the iLight user interfaces to activate scenes and sequences.

# Specification

## Electrical

Supply: 230 volts +/- 10% 50/60 Hz 1 Amp (optionally, 127 volt 60 Hz)

Protection: Requires external circuit breaker

## Load Types:

DMX controlled loads

## Terminal Sizes:

Incoming supply, max' cable size: 4mm<sup>2</sup>

iCANnet™ network cable size: 5 x 1mm<sup>2</sup>

DMX output: 2 x 1mm<sup>2</sup>

## Memory:

FLASH memory to be able to upgrade software  
EEPROM for 128 scene memory

Fade Times: 0.1 seconds to 60 minutes

## Environmental Data

Temperature: 0°C to 40°C

Humidity: 0 to 95% non-condensing

# Dimensions

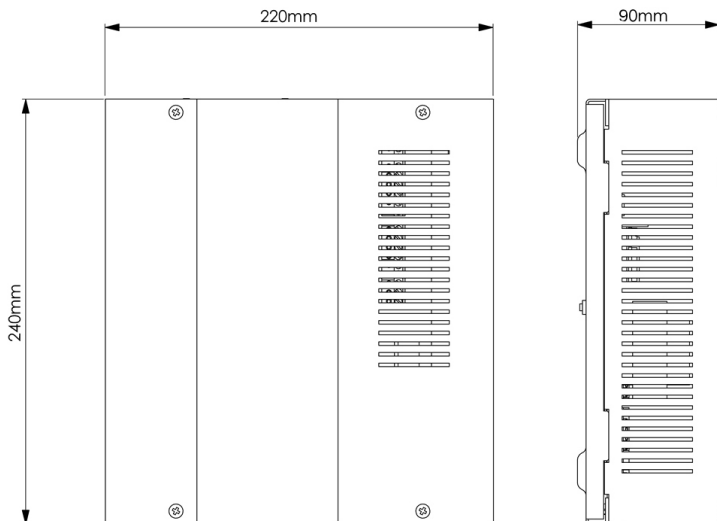

# Mounting

The unit is provided with four 6mm diameter fixing holes for wall mounting.

The mounting holes can be accessed by undoing the four screws on the front cover and removing it.

The unit should be installed in a dry ventilated location, where ambient temperature and humidity are within the operating temperature of the unit.

The unit has ventilation slots on its sides to allow convection cooling and under no circumstances should these be blocked.

Recommended minimum clearance around the unit is 100mm each side of the unit and 50mm above and below the unit if trunking with a depth greater than 50mm is used.

# DMX Connections

The SCD24 has 24 channels of DMX that can be configured via the iLight programming software.

Connections are made via the 4-way 2 part terminal block. Connections are:

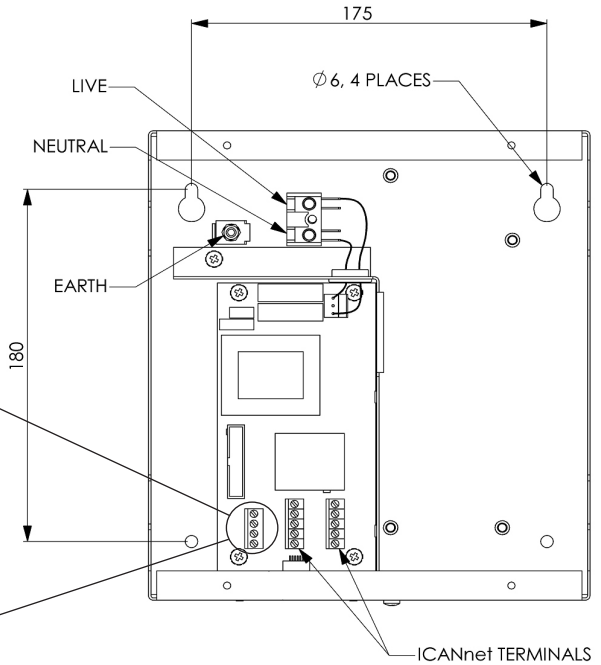
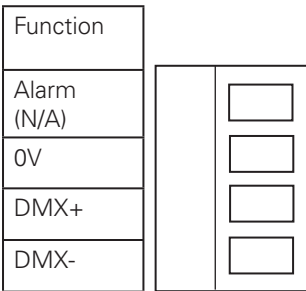

# Connecting Mains Supply

This unit requires a nominal 230V single phase supply (Live, Neutral and Earth) with 1A capability. A separate isolator and secure mains earth are required.

All wiring should be completed in accordance with local wiring regulations.

The unit is supplied with a knockout for mains cable entry. An appropriate cable gland should be fitted to the knockout hole provided to protect the mains cable from damage.

Ensure all mains connections are fully tightened and lock-washers used where supplied.

# Network Connections

Connections for the iCAN network are located on the CPU card at the bottom of the unit with the cover removed.

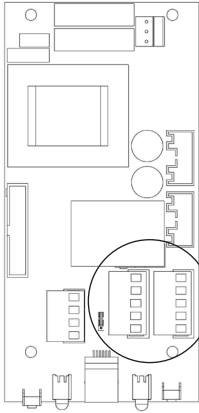

There are two 5-way green connectors for the network. Either of these may be used (as an in and an out) or a single used with the network cable doubled-up to it.

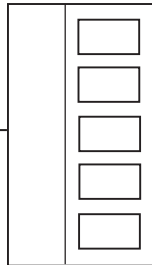

Function	Network Cable Colour
0V	Black
CAN L	White
Shield	Silver
CAN H	Blue
+12Vdc	Red

**IMPORTANT NOTE:** Connecting a mains potential cable to the iLight Network terminals is likely to damage the unit and others connected, and invalidate warranty.

# Network Termination

Applies 120Ω resistor to the iCAN network.  
Required at each end of the network cable run only.

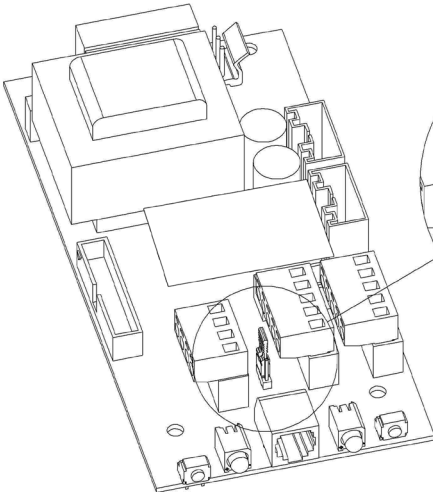

Termination On = Jumper across upper pins  
Termination Off = Jumper across lower pins

**IMPORTANT:** Ensure jumper is in the off position for all devices other than those at the end-of-line.

# Service Switches and LEDs

These switches and LEDs are located at the base of the unit.

The two service switches on the source controllers are used for the following:

- Entering Diagnostic Mode.
- Putting the Source Controller in override mode.
- Sending a message to identify the device on the network.
- Sending a message to identify the device on the network.

## NORMAL RUNNING MODE

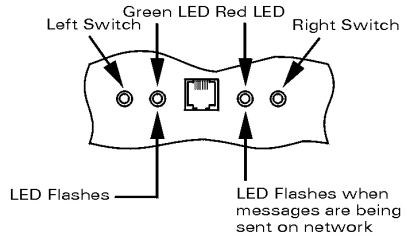

The LEDs indicate the following:

- Normal operation:  
Steady green LED blinking  
1 x per second.  
Red LED off.
- Message transmission and receipt indicated by red LED flashing for duration of data transmission.
- Override status: Both LEDs flashing together or just red flashing and green off.

## DEVICE IDENTIFICATION

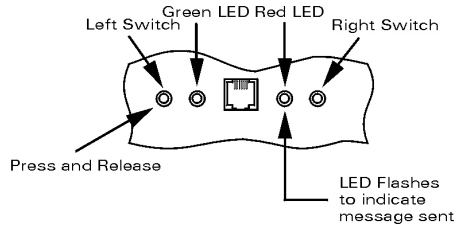

## iCAN Network Comms Error

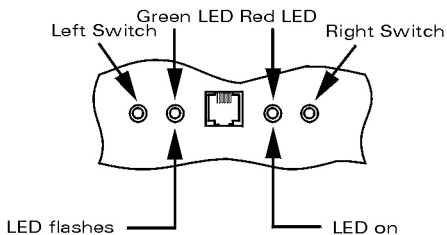

iCAN network error status will occur when a Source Controller is not connected to an iCAN network for any reason. Once either connected to a network of one or more other devices which are powered the error status will be removed. It is still possible to enter Diagnostic mode if a Source Controller is in iCAN network error status.

## ENTERING DIAGNOSTIC MODE

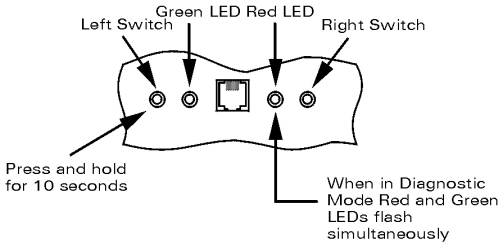

## OVERRIDE MODES

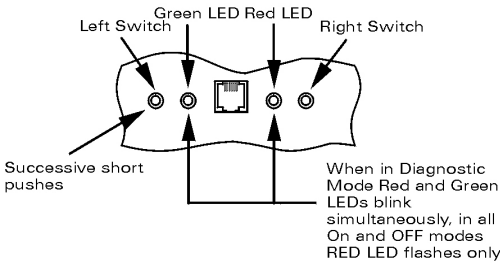

## SEQUENTIAL TEST MODE

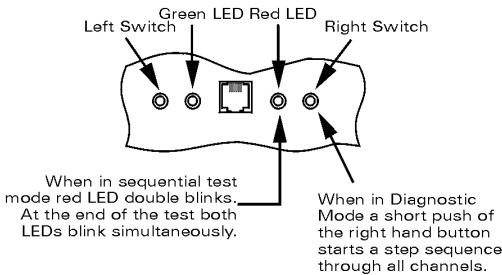

## EXITING DIAGNOSTIC MODE

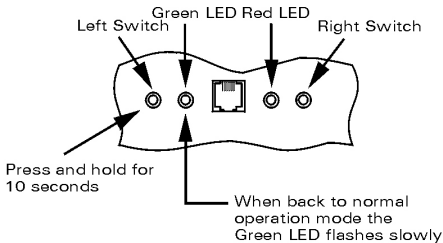

## Override Mode

Placing the unit into override mode allows for testing of the Source Controller outputs regardless of how the unit is currently programmed. This is useful for testing power to circuits prior to the system being commissioned or for fault finding where it can be used to test if there is an issue with the Source Controller output(s) should this be suspected.

When the Source Controller is placed into override mode it will no longer respond to commands sent over the iCAN network.

Override mode can also be used to restore power to outputs if control is lost or temporarily removed to allow lighting to remain on until control is restored.

NOTE: Override mode only affects the outputs on the Source Controller on which it is activated.

To exit diagnostic / override status follow the steps shown. If power is cycled to the Source Controller then this will also take the unit out of override mode and it will start up in the default running status.

## iLight Technical Support

Tel: +44 (0)844 324 9100 (available Mon-Fri 9am-5pm GMT)

Email: TechSupportCC@eaton.com

Web: [www.iLight.info](http://www.iLight.info)

---

All products manufactured by Eaton Lighting Systems and identified with the iLight product series mark are warranted to be free from defects in material and workmanship and shall conform to and perform in accordance with Seller's written specifications. For detailed warranty information, contact Eaton Lighting Systems.

This warranty will be limited to the repair or replacement, at Seller's discretion, of any such goods found to be defective, upon their authorized return to Seller. This limited warranty does not apply if the goods have been damaged by accident, abuse, misuse, modification or misapplication, by damage during shipment or by improper service.

There are no warranties, which extend beyond the hereinabove-limited warranty, INCLUDING, BUT NOT LIMITED TO, THE IMPLIED WARRANTY OF MERCHANTABILITY AND THE IMPLIED WARRANTY OF FITNESS.

No employee, agent, dealer, or other person is authorised to give any warranties on behalf of the Seller or to assume for the Seller any other liability in connection with any of its goods except in writing and signed by the Seller. The Seller makes no representation that the goods comply with any present or future federal, state or local regulation or ordinance. Compliance is the Buyer's responsibility.

The use of the Seller's goods should be in accordance with the provision of the National Electrical Code, UL and/or other industry or military standards that are pertinent to the particular end use. Installation or use not in accordance with these codes and standards could be hazardous.



CE compliant to all relevant standards



*Powering Business Worldwide*

### Eaton Lighting Systems

Usk House, Lakeside, Llantarnam Park,

Cwmbran, NP44 3HD, UK

T: +44 (0)1923 495495 F: +44 (0)1923 228796

E: [LightingControlSolutions@eaton.com](mailto:LightingControlSolutions@eaton.com) [EatonLightingSystems.com](http://EatonLightingSystems.com)